

バケット本体

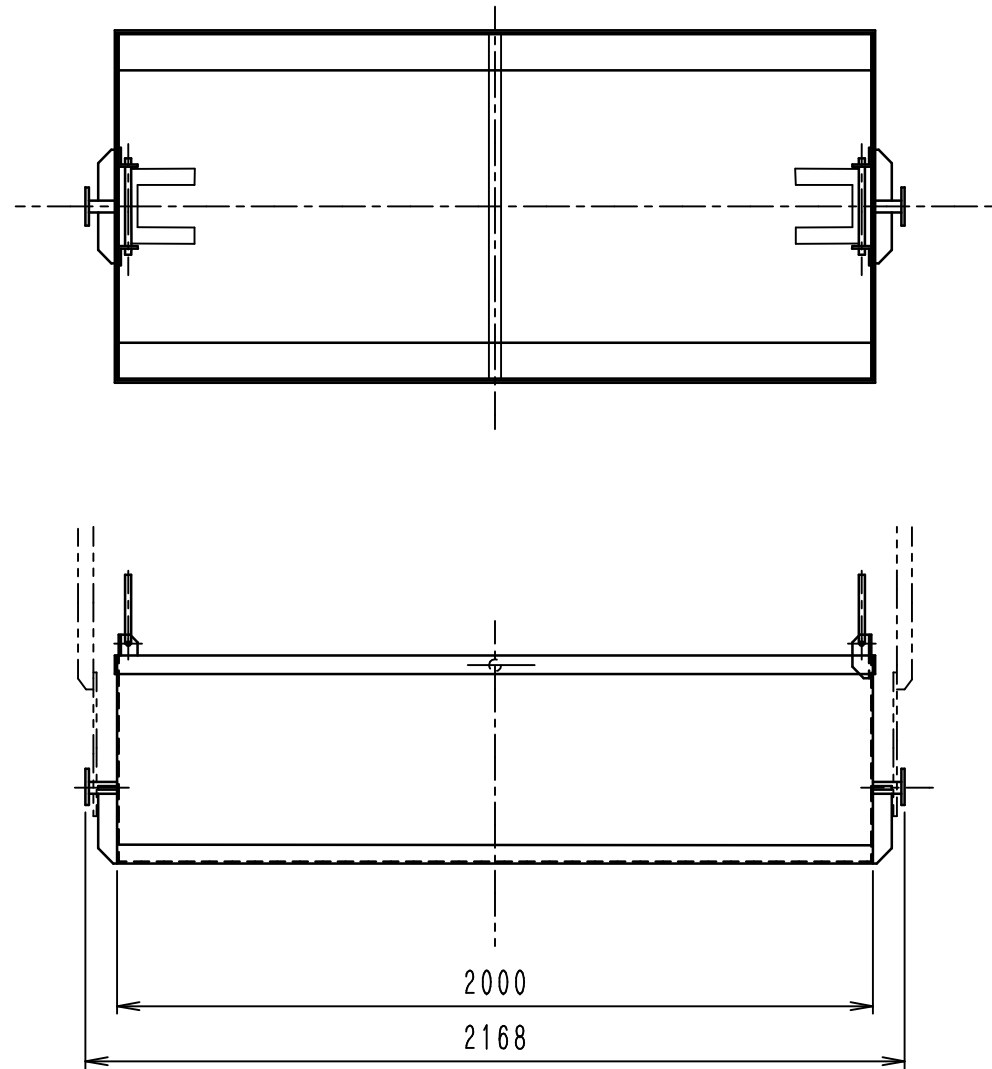

吊上げ金具

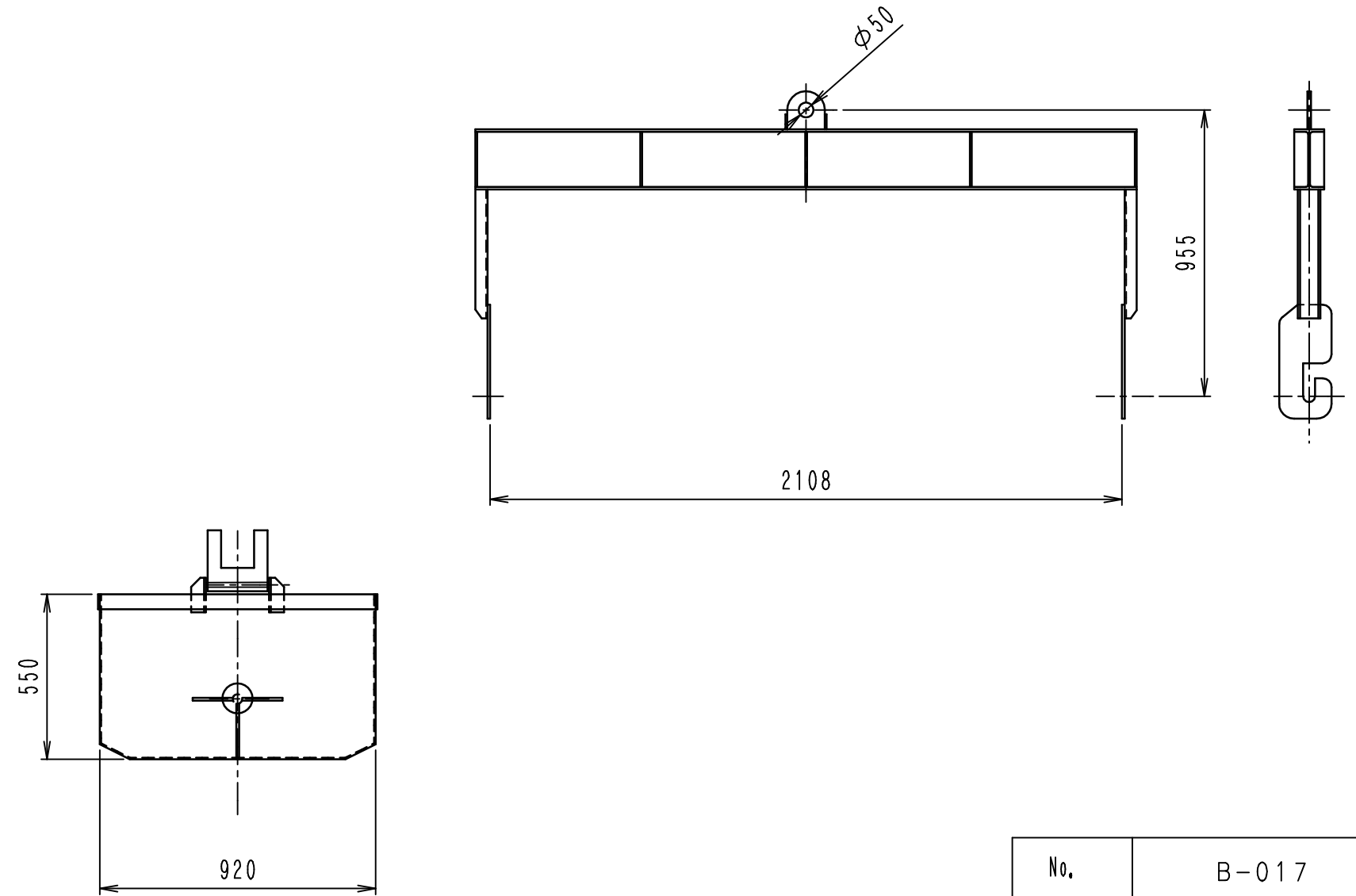

No.	B-017
容積	1.0m ³
自重	173Kg

DEPUTY MANAGER		株式会社ちよだ製作所	WORK NO.	QUANTITY
CHIEF		オートキャリー	CLASSIFICATION	SCALE
CHECKD BY		反転バケット		1/20
DRAWN BY	池津H	1.0m ³	DRAWING NO.	B-017
DATE DRAWN	H22.06.01	DATE ISSUED		

CHIYODA Manufactory Company